

Mutations in a Novel, Cryptic Exon of the Luteinizing Hormone/Chorionic Gonadotropin Receptor Gene Cause Male Pseudohermaphroditism

Nina Kossack¹, Manuela Simoni¹, Annette Richter-Unruh², Axel P. N. Themmen³, Jörg Gromoll^{1*}

1 Institute of Reproductive Medicine, University of Muenster, Muenster, Germany, **2** Endokrinologikum Ruhr, Bochum, Germany, **3** Department of Internal Medicine, Erasmus Medical Centre, Rotterdam, The Netherlands

Funding: Parts of this study were supported by the German Research Foundation (DFG GR 1547/6–1), by the fund “Innovative Medical Research” of the University of Münster Medical School (SI 110517), and by a US National Institutes of Health grant DK069711. The funding agencies did not have any role in study design, data collection and analysis, decision to publish, or preparation of the manuscript.

Competing Interests: The authors have declared that no competing interests exist.

Academic Editor: Paolo Beck-Peccoz, Institute of Endocrine Sciences, Italy

Citation: Kossack N, Manuela Simoni M, Richter-Unruh A, Themmen APN, Gromoll J (2008) Mutations in a novel, cryptic exon of the luteinizing hormone/chorionic gonadotropin receptor gene cause male pseudohermaphroditism. *PLoS Med* 5(4): e88. doi:10.1371/journal.pmed.0050088

Received: October 19, 2008

Accepted: March 10, 2008

Published: April 22, 2008

Copyright: © 2008 Kossack et al. This is an open-access article distributed under the terms of the Creative Commons Attribution License, which permits unrestricted use, distribution, and reproduction in any medium, provided the original author and source are credited.

Abbreviations: CG, chorionic gonadotropin; DSD, disorder(s) of sex development; ESE, exon splicing enhancer; LCH, Leydig cell hypoplasia; LH, luteinizing hormone; LHCGR, luteinizing hormone chorionic gonadotropin receptor; NMD, nonsense-mediated mRNA decay; RT-PCR, reverse transcription PCR; SEM, standard error of the mean

* To whom correspondence should be addressed. E-mail: Joerg.Gromoll@ukmuenster.de

ABSTRACT

Background

Male pseudohermaphroditism, or Leydig cell hypoplasia (LCH), is an autosomal recessive disorder in individuals with a 46,XY karyotype, characterized by a predominantly female phenotype, a blind-ending vagina, absence of breast development, primary amenorrhea, and the presence of testicular structures. It is caused by mutations in the luteinizing hormone/chorionic gonadotropin receptor gene (*LHCGR*), which impair either LH/CG binding or signal transduction. However, molecular analysis has revealed that the *LHCGR* is apparently normal in about 50% of patients with the full clinical phenotype of LCH. We therefore searched the *LHCGR* for novel genomic elements causative for LCH.

Methods and Findings

In the present study we have identified a novel, primate-specific bona fide exon (exon 6A) within the *LHCGR* gene. It displays composite characteristics of an internal/terminal exon and possesses stop codons triggering nonsense-mediated mRNA decay (NMD) in *LHCGR*. Transcripts including exon 6A are physiologically highly expressed in human testes and granulosa cells, and result in an intracellular, truncated LHCGR protein of 209 amino acids. We sequenced exon 6A in 16 patients with unexplained LCH and detected mutations in three patients. Functional studies revealed a dramatic increase in the expression of the mutated internal exon 6A transcripts, indicating aberrant NMD. These altered ratios of *LHCGR* transcripts result in the generation of predominantly nonfunctional LHCGR isoforms, thereby preventing proper expression and functioning.

Conclusions

The identification and characterization of this novel exon not only identifies a new regulatory element within the genomic organization of *LHCGR*, but also points toward a complex network of receptor regulation, including events at the transcriptional level. These findings add to the molecular diagnostic tools for LCH and extend our understanding of the endocrine regulation of sexual differentiation.

The Editors' Summary of this article follows the references.

Introduction

The gonadotropic hormones luteinizing hormone (LH) and chorionic gonadotropin (CG) play an essential role in male sexual differentiation. The action of both hormones is mediated by the LH/CG receptor (LHCGR), a G protein-coupled receptor, expressed in Leydig, granulosa-lutein, and theca cells. The human *LHCGR* gene (NCBI GeneID 3973; <http://www.ncbi.nlm.nih.gov/>) consists of 11 exons and ten introns, and spans 67 kbp on Chromosome 2 p21. Ten of the 11 exons encode the extracellular domain, while exon 11 encodes the seven-transmembrane and intracellular domains [1]. Several inactivating *LHCGR* mutations have been described in patients with 46,XY disorder of sex development (46,XY DSD) due to Leydig cell hypoplasia (LCH), an autosomal recessive disorder characterized by a predominantly female phenotype with a blind-ending vagina, absence of breast development, and primary amenorrhea and the presence of testicular structures [2]. However, in a substantial number of patients (50%) with the classical symptoms of LCH, no mutations of the *LHCGR* are found (unpublished data) [3,4]. This finding raises the hypothesis that genomic defects in other genes or in *LHCGR* regions not considered so far may cause LCH. In this study we therefore searched the *LHCGR* gene for novel genomic elements in which genetic alterations could lead to LCH.

Methods

Study Participants

Patients. Sixteen patients with complete LH resistance (male pseudohermaphroditism) due to LCH type 1 gave written informed consent to participate in the study. All patients had karyotype 46,XY, a blind-ending vagina, no breast development, and testicular structures in the abdomen and displayed the full phenotype of LCH [4]. All patients had been previously screened for *LHCGR* mutations and found to be negative.

The patients in this manuscript have given written informed consent (as outlined in the PLoS publication consent form, http://journals.plos.org/plos_consent_form.pdf) to publication of their case details.

Control group. Forty-one fertile men with normal LH and testosterone levels and normal spermatogenesis were included as a control group. The institutional review board approved the study and written informed consent was obtained from each participant.

Case reports. A 20-year-old Turkish woman was referred to the gynecologist because of primary amenorrhea. She was the first daughter of a sibship of three children from consanguineous parents. She presented with a lack of breast development, normal pubic and axillary hair, blind-ending vagina (4 cm), and normal labia majora and minora. No clitoris hypertrophy was seen. She was obese (122 kg, 173 cm). Testes were palpable in the inguinal regions, but no müllerian derivatives were found by ultrasound. Karyotyping was performed and revealed a 46,XY karyotype. Hormone analysis showed very low serum testosterone levels (0.1 nmol/l), which could be not stimulated by treatment with 7,500 IU of hCG (maximal testosterone levels, 0.1 nmol/l). Serum levels of LH and FSH were elevated (LH 15.8 IU/l, FSH 13.6 IU/l) and responsive to stimulation with 100 µg of GnRH (LH 69.8 IU/l, FSH 20.1 IU/l).

At the age of 26 y her sister, younger by 6 y, was referred to the Department of Endocrinology of the University of Essen also because of primary amenorrhea. She presented with the same phenotype as her older sister: 46,XY karyotype, blind-ending vagina (6 cm), inguinal gonads, obesity (126 kg, 176 cm), low estradiol level (21 pg/ml), low testosterone level (0.06 nmol/l, increasing to 1.9 nmol/l after 7,500 IU of hCG), elevated gonadotropin level (LH 24.3 IU/l, FSH 20.1 IU/l) responsive to 100 µg of GnRH (LH 98.0 IU/l, FSH 29.6 IU/l). Gonadectomy was performed and histological evaluation revealed complete Sertoli cell-only syndrome with thickened tubule walls and focally disorganized tubules. Leydig cells appeared immature and their number was not evidently changed when compared to normal testes. In both affected sisters the previously performed genetic analysis of the *LHCGR* gene did not give any hint of mutations or other genetic alterations in other candidate genes.

A third patient was analyzed for mutations in the *LHCGR* gene at the age of 21 mo. She was born to unrelated parents and presented a female phenotype with labial synechia. Gonads were palpable in both labia majora and a karyotype 46,XY was found. Postnatal testosterone levels were low and the girl was gonadectomized at the age of 2 mo. Histology showed fibrotic testis tissue. A heterozygous mutation leading to a Thr461Ile substitution in exon 11 of the *LHCGR* gene, resulting in complete inactivation, was found.

Cells and Tissues

Human testis tissues were obtained from patients undergoing orchidectomy because of prostate cancer, and granulosa cells were obtained from women undergoing assisted reproduction. Written informed consent was obtained from the patients to use their material for scientific research. In addition, human adrenal and testis RNA was purchased from a commercial source (Biocat, Heidelberg, Germany).

Snap-frozen testes were obtained from different primate species within the framework of a project on efficacy of spermatogenesis funded by the German Research Foundation (WE1167/4–1/2). Tissue from the cynomolgus monkey (*Macaca fascicularis*) was obtained from our own primate colonies at the Institute of Reproductive Medicine (Muenster, Germany). All experiments were conducted according to the German Law on Animal Care and Experimentation. The cynomolgus monkey testis cDNA library has been described before [5].

Genomic DNA and RNA Isolation

Genomic DNA was isolated from EDTA-treated blood samples using the Flexigene DNA isolation kit (Hilden, Germany). RNA was isolated using UltraSpec (Biotecx, Houston, Texas, United States).

Exon Trap Experiments

Analysis of exon 6A was performed using the exon trapping system (Invitrogen, Karlsruhe, Germany). Plasmid constructs were generated by amplification of a DNA fragment from human genomic DNA using the specific primers Ex6a 150 fw (forward) 5'-CGCTCGAGCCTGCCCTCCTCGGCCCTCCCAAAG-3' and *LHCGR* Ex6a 150 rev (reverse) 5'-CGCGGATCCCTTTATAAGCAGCCGGTAGAGCTG-3' containing the restriction site XhoI within the forward primer or BamHI for the reverse primer. The fragment was amplified using the following thermocycler conditions: 94 °C for 50 s,

64 °C for 50 s, 72 °C for 90 s for 35 cycles. The obtained amplicon was restricted by XhoI and BamHI and cloned into the pSPL3 vector. Sequence fidelity was confirmed by DNA sequencing.

Transient Transfection and Reverse Transcription PCR

COS7 cells were seeded on petri dishes and cultured to 40%–50% confluency. 12 µg of plasmid DNA per dish was used for transfection by Lipofectamine (Invitrogen, 12 µl/dish). 6 h later the transfection was stopped by adding DMEM supplemented with 20% FCS. 48 h later the cells were lysed using UltraSpec and RNA isolated according to the manufacturer's protocol. Reverse transcription was performed using the vector-specific primers SA2 5'-TCTGAGTCACCTG-GACAACC-3' and exon 6A rev (reverse) 5'-GTAACATGACATTATACATG-3', or β-actin reverse primer as a control for RNA integrity. Subsequent PCR was performed with the primer combination SD6 5'-ATCTCAGTGGTATTTGT-GAGC-3' and SA2 (see above), or SD6/exon 6A rev (reverse) and β-actin for/rev (forward/reverse) using the following thermocycler conditions: 94 °C for 50 s, 60 °C for 50 s, 72 °C for 90 s for 35 cycles. The PCR reactions were subjected to 2% agarose gel electrophoresis and documented using the Multi-Image Light system (Biozym, Oldendorf, Germany). In functional experiments, COS7 cells were stimulated 24 h after transfection by hCG (Choragon, Ferring GmbH, Kiel Germany) dissolved in DMEM. Extracellular cAMP concentrations were determined 3 h after stimulation in media by radioimmunoassay.

In Vitro Mutagenesis

Mutations were introduced using the Quick Change site-directed mutagenesis kit from Stratagene (Heidelberg, Germany). Sequence fidelity was confirmed by DNA sequencing.

Real-Time Quantitative PCR for the Relative Gene Expression of *LHCGR* Variants

The commercially available TaqMan assay #HS20896337_m1 (*LHCGR*; Applied Biosystems, Darmstadt, Germany) was used to detect the known *LHCGR* transcripts (without exon 6A). For the relative quantification of the *LHCGR* terminal exon 6A and internal exon 6A variants, specifically designed assays were used. The terminal exon 6A assay is directed toward the 3' region of exon 6A, while the internal exon 6A variants are detected by an assay spanning the 5' region of exon 6A to exon 7 of the *LHCGR* gene. The primers and probes of the assays designed ad hoc are listed below.

Terminal exon 6A. Forward primer, 5'-CAGAG-GACTCTCTTTTATATCACTGGATTTC-3'; reverse primer, 5'-TGTCACAGCTTTGTAACATGACAA-3'; TaqMan MGB FAM-labeled probe, 5'-ACCAAGGATACCAATTTT-3'

***LHCGR* internal exon 6A short.** Forward primer, 5'-CTCTGAAATGAAGAGATAGATGTGAAGCA-3'; reverse primer, 5'-GCATGACTTTGTACTTCTTCAAATCCAT-3'; TaqMan MGB FAM-labeled probe, 5'-TTCCATATAGTTTG-CAATTTT-3'.

***LHCGR* internal exon 6A long.** Forward primer, 5'-CAGAGGACTCTCTTTTATATCACTGGATTTC-3'; reverse primer, 5'-TGACTTTGTACTTCTTCAAATCCATTTCCA-3'; TaqMan MGB FAM-labeled probe, 5'-ACTGCCTTTGTATAG-TACTTTTA-3'.

***LHCGR* exon 6/7 without exon 6A.** Forward primer, 5'-ACCACCATACCAGGAAATGCTTTT-3'; reverse primer, 5'-AAAGATTCACTGTCGTCCCATTGA-3' (AAAGAT correspond to vector sequence); TaqMan MGB Fam-labeled probe, 5'-CAAGGGATGAATAATGAATCTGT-3'

Assays. Reverse transcription of 2 µg of total RNA/tissue was performed using random hexamer primers and Superscript II enzyme according to the manufacturer's protocol (Invitrogen).

TaqMan PCR was performed using the following amplification profile: an initial step consisting of 50 °C for 2 min and 95 °C for 10 min followed by 40 cycles at 95 °C for 15 s and 60 °C for 1 min. PCR efficiency was verified with different cDNA concentrations yielding linear amplification. For the detection of the *LHCGR* variants 200 ng of cDNA per reaction were used.

The relative quantification of gene expression was analyzed according to Livak et al. [6] using the $2^{-\Delta\Delta CT}$ method. Normalization of RNA content was performed using 18S TaqMan gene expression assay (Hs # 99999901; Applied Biosystems). The mRNA levels of the known *LHCGR* (without exon 6A) in the testis tissue were used to calibrate by relative quantification the expression levels of the other transcripts.

LHCGR Minigene Constructs

The genomic region encompassing exon 6, exon 6A, and exon 7, with a total length of 9,534 bp, was amplified from genomic DNA of one patient with the A557C mutation and one male individual lacking the mutation using the Expand Long PCR kit by Roche (Mannheim, Germany). The following two primers and manufacturer-recommended thermocycler conditions were used: exon 6 for (forward) 5'-GTGATAACT-TACACATAACCACCATACCAGG-3' and exon 7 rev (reverse) 5'-GTCAGTGTCTGCCATTGAATGCATGAC-3'). The obtained amplicons were cloned into the pTarget expression plasmid (Promega, Germany) and sequence fidelity was confirmed by DNA sequencing.

These constructs were further modified for signal transduction studies. To mimic the in vivo situation as close as possible we engineered a construct consisting of *LHCGR* cDNA and embedding the genomic intron 6 with exon 6A. To reduce the length of the intron to a manageable size the minigene constructs with the genomic region encompassing intron 6 from both wild-type and A557C *LHCGR* were digested with EcoRV, 6,209 bp were removed from the intronic region 3' of exon 6A, and the remaining parts were re-ligated. A functional analysis of the shortened constructs revealed a similar splicing pattern to the full-length construct. Thereafter, a three-step cloning strategy was employed. In the first step cDNA from exons 1–6 was amplified and joined to the 5' end of the shortened minigene construct by overlapping PCR, yielding a product containing exons 1–6, shortened intron 6, and exon 7; this product was subsequently cloned into the pTarget vector. In the second step, the 3' end of shortened minigene construct was joined to exons 7–11, yielding a product containing exon 6, shortened intron 6, and exons 6–11; this product was also cloned into the pTarget vector. In the third step both constructs were digested with SacI and a fragment containing exons 1–6 and extending into the intronic region was used to replace the 5' part of the construct encoding exon 6, intron 6, and exons 7–11. The resulting construct consisted of a chimera of partial *LHCGR*

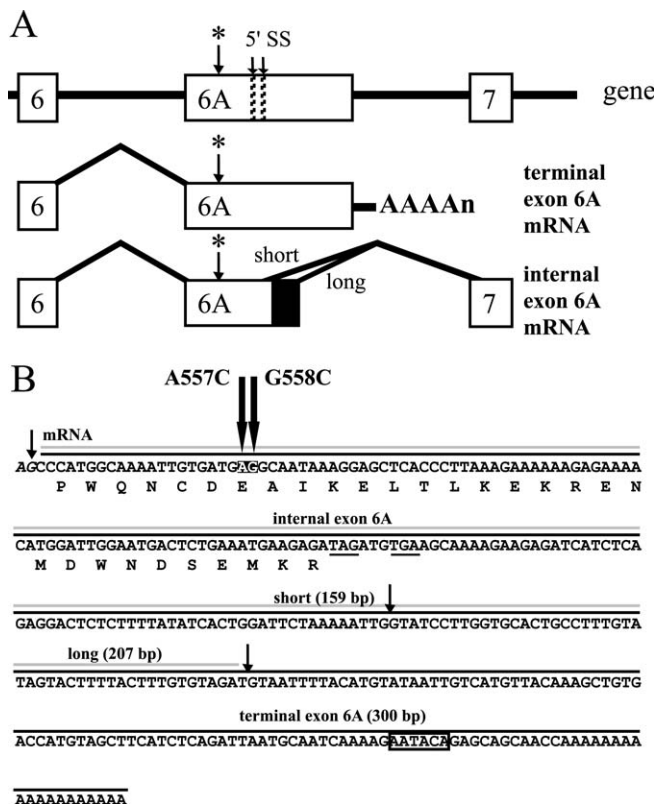

Figure 1. Identification and Characterization of Exon 6A

(A) Upper diagram: Schematic representation of the composite internal/terminal exon 6A and its location in the *LHCGR* gene. The asterisk indicates the translational stop codon. 5' SS indicates the 5' splicing sites. Middle diagram: Structure of the *LHCGR* mRNA when exon 6A is acting as a terminal exon. Lower diagram: Structure of the *LHCGR* mRNA when exon 6A is acting as an internal exon.

(B) cDNA nucleotide sequence and putative amino acid sequence of exon 6A. The three different variants of exon 6A are indicated by the grey line (internal short and long exon 6A) and black line (terminal exon 6A). Stop codons are underlined and the polyadenylation signal is boxed. The 3' and 5' splice sites are indicated by small arrows and the position of the identified mutations by bold arrows. Numbering of nucleotides is according to the *LHCGR* mRNA where the translational initiation codon ATG is considered as +1 (adenosine).

doi:10.1371/journal.pmed.0050088.g001

cDNAs and intron 6 containing exon 6A. Sequence fidelity was repeatedly verified by complete DNA sequencing of the different constructs. Primers used for amplification were as follows. *LHCGR* exons 1–6, forward primer 5'-ATGAAG-CAGCGTTCCTCGGCGCTGC-3'; reverse primer 5'-GCATTTCTGGTATGGTGGTTATGTGTAAGTTATCAC-3'. *LHCGR* exons 7–11, forward primer 5'-CAAATATATG-GAAATGGATTTGAAGAAG-3'; reverse primer 5'-TTAA-CACTCTGTGTAGCGAGTCTTGTC-3'.

Northern Blot Hybridization. Northern blots were either obtained from a commercial source (Human Adult Normal Tissue, Blot V, Biocat, Heidelberg, Germany,) or made from adult marmoset tissues (ovary, liver, muscle). Membranes were hybridized using the FastHyb Solution (BioChain, Heidelberg, Germany) at 42 °C overnight. As probes either a fragment containing only exon 6A or a full-length human *LHCGR* cDNA (lacking exon 6A) were used. Both probes were radioactively labeled using α -dCTP³² with specific activity of $> 2 \times 10^7$ cpm/ μ g DNA. Blots were sequentially hybridized to

the two probes. After hybridization washing was performed using 0.1 SSC/0.5% SDS at 65 °C. Blots were exposed for 1–6 h in Phosphorimager cassettes and developed by a Phosphorimager (Storm 860, Molecular Dynamics)

Protein Expression of the Full-Length *LHCGR* and of the *LHCGR* Terminal Exon 6A Variant

The protein expression studies of *LHCGR* exon 6A were performed using a human HA-tagged, full length *LHCGR* cDNA cloned into the pcDPS expression plasmid (kindly provided by Dr. T. Gudermann, University of Marburg, Germany). The HA tag is directly located after the *LHCGR* signal peptide and can be visualized by immunofluorescence using a HA-specific antibody (sc 7392, Santa Cruz, California, United States). The *LHCGR* exon 6A variant was generated by a restriction enzyme-based cloning strategy, using Hind III and SpeI, thereby removing most of the *LHCGR* cDNA except the most N-terminal part, which subsequently was joined to an *LHCGR* exon 6A variant treated with the same restriction enzymes beforehand. Both constructs were transiently transfected into COS7 cells and immunofluorescence was detected by using the HA antibody followed by a monoclonal IgG2a antibody (Sigma, Deisenhofen, Germany) and fluorescence was imaged by a Zeiss Axioscope microscope.

Web Resources

Sequence alignments were performed using the ClustalW program (<http://www.ebi.ac.uk/Tools/>). Exon splicing binding sites were identified using the exon splicing enhancer (ESE) finder software (<http://rulai.cshl.edu/tools/ESE/>). Other searches were performed using the toolbox of the Alternative Splicing Database project (<http://www.ebi.ac.uk/asd/>). Chimpanzee *LHCGR* sequences were extracted from the NCBI Nucleotide database at http://www.ncbi.nlm.nih.gov/entrez/viewer.fcgi?list_uids=114577822.

Results

A Cryptic, Functional Exon in the *LHCGR* Gene

In our effort to clone *LHCGR* variants we screened a cynomolgus testis cDNA library and human granulosa cell mRNA for *LHCGR* transcripts, and systematically identified unusual *LHCGR* variants consisting of exons 1 to 6 and additional unknown sequences either terminated by a poly(A) tail or continuing with exons 7–11 (Figure 1A). A BLAST search yielded a perfect match to the intronic region between exon 6 and 7 of the human *LHCGR* gene (from nucleotide position 33,900 to 34,200). Inspection revealed the presence of a 3' splice acceptor site (AG) and a 3' polyadenylation signal (AATAAA) indicative of a terminal exon [7]. Moreover, two internal 5' splice sites were evident which, together with the 3' acceptor site, give rise to a 159 bp (short) or to a 207 bp (long) internal exon (Figure 1B). Therefore, the human *LHCGR* gene contains an additional, previously unrecognized putative exon within intron 6 that can be spliced into the novel *LHCGR* transcripts following two different routes. We designated this new exon as exon 6A.

Exon trap experiments with the human genomic region surrounding exon 6A yielded two transcripts including either 159 bp (short) or 207 bp (long) of the internal exon 6A, indicating specific splicing (Figure 2A, agarose gel lane 1). A

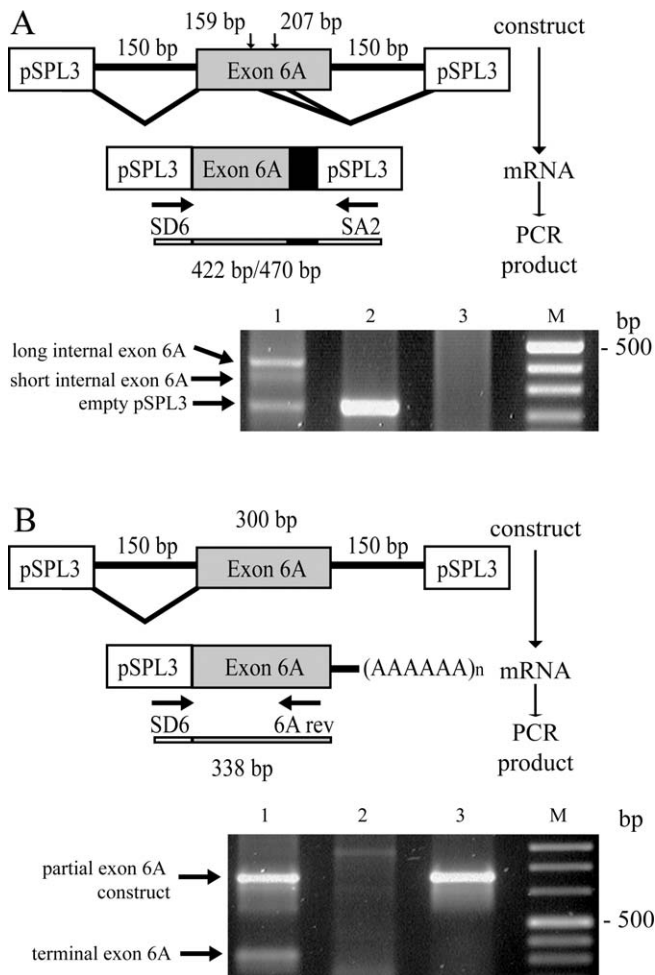

Figure 2. Exon 6A Is a Bona Fide Exon

Exon trap experiments with exon 6A. A genomic fragment of intron 6 of the human *LHCGR* gene including exon 6A and 150 bp upstream and downstream was cloned into the pSPL3 expression vector. COS7 cells were transiently transfected with this construct and RT-PCR performed. Primers for the detection of either internal exon 6A (A) or terminal exon 6A (B) are indicated by the arrows. A representative gel electrophoresis is shown below each expected PCR product. RT-PCR results of COS7 cells transfected with either the pSPL3 construct containing exon 6A (lane 1) or empty pSPL3 vector (lane 2) or untransfected COS7 cells (lane 3 in [A]) are shown. The agarose gel photograph in (B) displays the detection of the spliced terminal exon 6A variant. This splice variant can be obtained only in the exon trap system, when using a primer combination employing SD6 and 6A rev (lane 1 in [B]). In addition to the spliced mRNA variant a second amplicon arose by amplification of a partial fragment of the pSPL3 vector and the DNA construct covering 150 bp 5' to exon 6A and exon 6A. The second amplicon, deriving from the DNA construct is therefore also detectable in a reaction omitting the RT-synthesis (lane 3 in [B]). RNA fidelity was confirmed by the detection of β -actin mRNA. These results show that exon 6A is recognized as a bona fide exon and is spliced to give rise to two internal (A) and one terminal variant (B) mRNAs, as predicted by the primary genomic sequence. doi:10.1371/journal.pmed.0050088.g002

different primer set revealed the expression of the terminal exon 6A transcript as well (Figure 2B, agarose gel lane 1). Thus, exon 6A is a novel bona fide composite internal/terminal exon within the *LHCGR* gene. However, these experiments did not give any clues as to the presence of these exon 6A variants in native tissues. Therefore, using a different approach we analyzed and quantified the expression pattern of the known *LHCGR* mRNA and of the newly

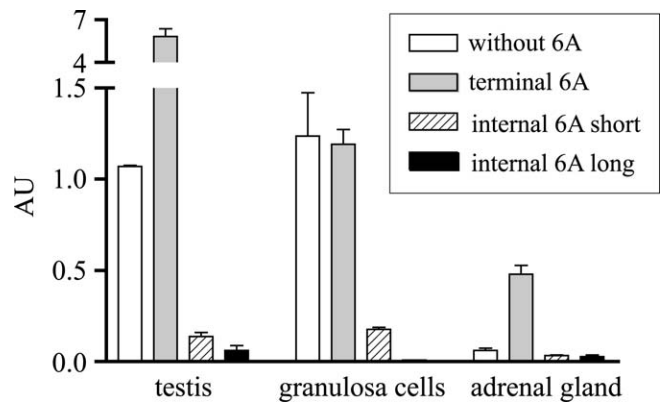

Figure 3. Tissue-Specific Expression of Exon 6A mRNA

Quantification of *LHCGR* transcripts in different human tissues by TaqMan RT-PCR. mRNA extracted from human testes and granulosa cells and from a commercially available adrenal gland preparation was analyzed. After normalization against 18S RNA, results were quantified with the testis transcript without exon 6A as the reference that was assigned an arbitrary unit (AU) value of 1. Results are shown as mean \pm SEM of three independent experiments. The amplicon without exon 6A represents the transcript that results in the mature, full-length *LHCGR* protein. Transcripts containing the terminal exon 6A are highly expressed in all tissues analyzed and show a 6-fold higher expression compared to those without exon 6A in testis and adrenal gland. In comparison, the expression level of the internal exon 6A transcripts is much lower in every tissue. doi:10.1371/journal.pmed.0050088.g003

discovered transcripts by real-time reverse transcription PCR (RT-PCR) in human tissues. As shown in Figure 3, high mRNA levels including exon 6A were detected in granulosa cells and in testes, where the terminal variant expression is about five times higher than that of the known mature mRNA without exon 6A. In addition, low levels of exon 6A transcripts were consistently detected in adrenal tissues. mRNA levels for the two internal exon 6A mRNA variants were significantly lower than in the known *LHCGR* without exon 6A (Figure 3).

The genomic region including exon 6A is perfectly conserved in the chimpanzee as shown by database sequence comparison. Moreover, we cloned and sequenced the corresponding genomic region in macaque, marmoset monkey, and lemur as representative species of the principal primate lineages (Figure S1) [8,9]. Exon 6A presumably arose from a 2.7 kbp insertion, which was found in all primates investigated in this study. Both the internal and the terminal exon 6A are highly conserved in these primates, but comparable sequences are completely lacking in mouse as well as in other species (Figure S1).

Exon 6A maintains phase 2 splicing typical of the *LHCGR* exon organization. However, it contains two stop codons (Figure 1) and encodes 30 amino acids ($pI = 4.5$) with no significant sequence homology to any other known protein according to FASTA and BLAST searches. The incorporation of either terminal or internal exon 6A into the transcripts results in a truncated *LHCGR* protein of 209 amino acids. The expression of such protein using a HA-tagged *LHCGR*-exon 6A vector in transiently transfected COS7 cells revealed a predominantly cytosolic localization (Figure S3). The presence of stop codons qualifies the *LHCGR* transcript containing the internal exon 6A as a target for NMD, a recently described protein-mediated surveillance mechanism that selectively degrades nonsense mRNAs, thereby regulating

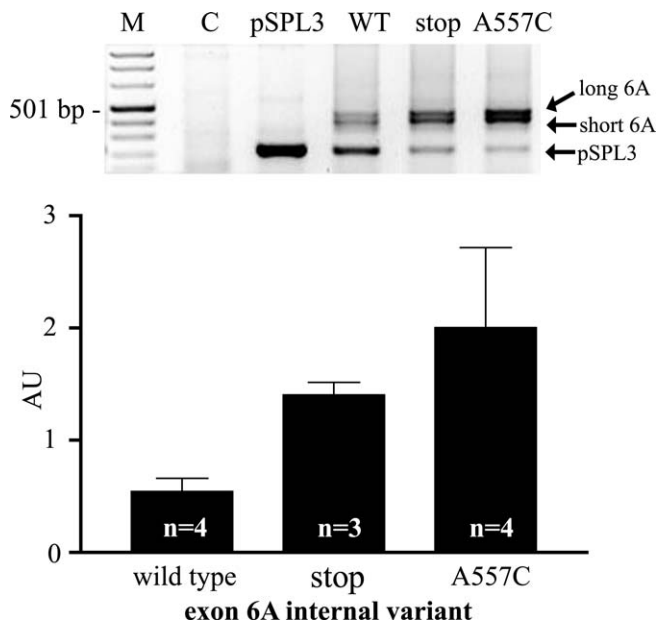

Figure 4. Mutation and Stop Codons Effect Exon 6A mRNA Expression
Analysis of internal exon 6A inclusion in exon trap experiments showing that removal of the two stop codons (stop) or the presence of the A557C mutation significantly increases inclusion of the internal exon 6A variants. Upper image The expression of the terminal and internal variants was analyzed after transfection in COS7 cells and RT-PCR of pSPL3 constructs containing the wild-type (WT) exon 6A (along with 150 bp 5' and 3': see Figure 2) or exon 6A after removal of the two stop codons (stop) or the introduction of the A557C mutation. Lower histogram: Densitometric quantification (in arbitrary units, AU) of internal exon 6A variants RT-PCR results (both short and long variant together) of three or four independent experiments, as indicated in the columns. Results are expressed as mean \pm SEM. $p = 0.0294$ (Kruskal-Wallis test). Results suggest that removal of the stop codons or a mutation in the SRp55 site reduces NMD of the internal exon 6A transcripts.
doi:10.1371/journal.pmed.0050088.g004

protein expression [10]. Elimination of the stop codons by in vitro mutagenesis significantly increased the efficiency of internal exon 6A inclusion rate in transiently transfected COS7 cells (Figure 4). Similar results were obtained when transfected cells were treated with cycloheximide, a strong protein synthesis inhibitor, for 4 h (unpublished data). These results indicate that exon 6A might function as novel regulator of *LHCGR* mRNA levels and transcript pattern. Upon inclusion of the internal exon 6A, an NMD-mediated process probably results in degradation of the *LHCGR* transcript, while inclusion of terminal exon 6A result in an intracellular, truncated *LHCGR* protein. Whether the deduced truncated 209 amino acid protein occurs naturally in testis and ovary remains unknown because appropriate antibodies are not available.

In order to further verify the natural occurrence of mRNA transcripts including exon 6A, we performed Northern blot hybridization experiments using specific probes containing either only exon 6A or the whole *LHCGR* cDNA without exon 6A (Figure 5). Hybridization of human and marmoset ovarian mRNA revealed a unique and consistent binding pattern of the exon 6A probe resulting in a "comet-like" pattern in the range of 0.5 to 1.4 kb. This finding was specific for the human and marmoset ovary and was not observed in any other tissues tested. The comet-like appearance of exon 6A hybridization in the presence of distinct band patterns

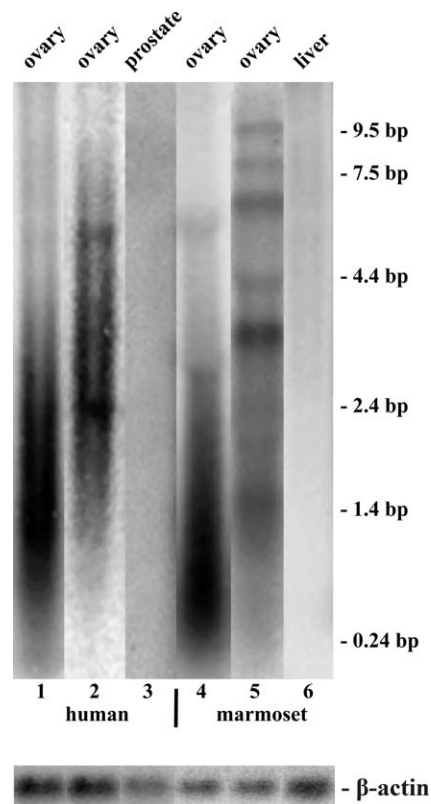

Figure 5. Exon 6A-Specific Transcripts as Detected by Northern Blot Hybridization

Commercially available Northern blots containing human adult normal tissues and Northern blots from adult marmoset tissues were sequentially hybridized to an exon 6A probe or the human full-length *LHCGR* cDNA.

Lanes 1 and 4, exon 6A probe. Lanes 2 and 5, full-length *LHCGR* cDNA probe. Lanes 3 and 6, negative control tissues hybridized either to *LHCGR* cDNA (lane 3) or to exon 6A (lane 6). Blots were exposed for 1–6 h using a Phosphorimager. An RNA marker was used for size determination of the different transcripts. One Northern blot hybridization out of three independent experiments is shown. While a range of discrete transcripts is identified using the full-length *LHCGR* cDNA probe, a comet-like hybridization pattern, probably representing degraded mRNA transcripts, is detected by an exon 6A-specific probe. These results indicate that (i) transcripts containing exon 6A are naturally present in the ovary and (ii) they undergo massive degradation, possibly by NMD. β -actin hybridization results are given to demonstrate RNA integrity.
doi:10.1371/journal.pmed.0050088.g005

characteristic for the *LHCGR* mRNA (ranging from 2.3 to 9.5 kb) using the full-length *LHCGR* cDNA probe, suggests mRNA degradation, consistent with the hypothesis that the *LHCGR* exon 6A internal variants probably undergo NMD.

Mutations of Exon 6A Are Associated with LCH/46,XY DSD

We screened 16 clinically well-characterized patients with the overt phenotype of LCH and no known mutations in *LHCGR* gene for genetic alterations in exon 6A. Three single nucleotide polymorphisms (SNPs) were identified, for which the first represents a nonsynonymous SNP at nucleotide position 599 (starting from exon 1, rs4637137, NCBI-SNP database, <http://www.ncbi.nlm.nih.gov/SNP/>) of the *LHCGR* changing ATG (Met) into ACG (Thr). The other two SNPs are located at nucleotide position A653G (rs4490239, SNP database) and at nucleotide position T748G (not found in the SNP database) within the noncoding region of exon 6A. Determi-

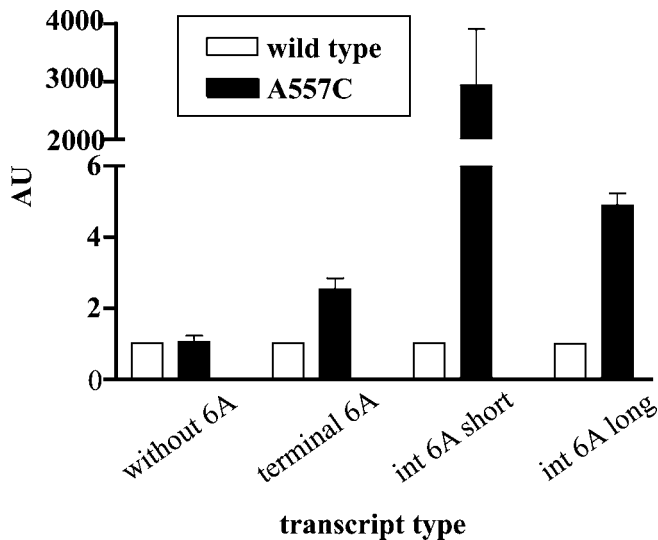

Figure 6. The A557C Mutation Increases the Expression of the Exon 6A Short Internal Variant

A 9.5 kb genomic DNA fragment encompassing exon 6 to exon 7 of the *LHCGR* gene from one patient carrying the A557C mutation and one control (wild type) was cloned into the pTarget expression vector and transiently transfected in COS7 cells. Expression of each variant was quantified by TaqMan RT-PCR. Results of three independent experiments (mean \pm SEM) are expressed in arbitrary units (AU) after relative quantification against the respective wild-type variant, which was arbitrarily given an AU value of 1. doi:10.1371/journal.pmed.0050088.g006

nation of the different SNPs in the patient group and in a cohort of 41 males lacking mutations showed similar distribution and frequencies. The SNPs T599C and A653G appear to be in LD (Table S1).

Apart from these SNPs present also in an appropriately sized control group, we identified three patients from two families with mutations of exon 6A. In two sisters with LCH we found a homozygous A to C mutation at position 557 within exon 6A, leading to an amino acid change from Glu (GAG) to Ala (GCG) (Figure 1B). The two patients were from consanguineous parents who each carried the same heterozygous mutation, but without any apparent phenotype. An immunofluorescence-based comparison of the mutated *LHCGR* terminal exon 6A protein variant using a HA-tagged *LHCGR* and the wild-type *LHCGR* terminal exon 6A protein variant yielded no obvious difference; in both cases a predominantly cytosolic localization was observed (Figure S3). A heterozygous G to C transversion at position 558 of exon 6A was found in another patient with LCH from an independent family who was concomitantly carrier of a heterozygous inactivating mutation in exon 11 of the *LHCGR*, leading to the complete absence of signal transduction upon stimulation with hCG (Figure S5A). The two mutations were located on different alleles (compound heterozygosis; Figure S5B).

According to the ESE finder software, the A557C mutation strengthens and the G558C mutation abolishes a binding site for the splicing factor SRp55 (consensus sequence TGCGTC, mutation sites underlined). We therefore analyzed the effects of the mutations on the *LHCGR* transcript pattern in vitro. Exon trap experiments revealed a 4-fold higher expression level of the A557C exon 6A (Figure 4) and a 6-fold increase of

the G558C (Figure S5C) internal variants compared to wild type. The entire *LHCGR* genomic region from exon 6 to exon 7 from one patient with the A557C exchange and from one control were cloned and expressed in COS7 cells, and the transcript pattern quantified by real-time RT-PCR. The mutation did not induce any change in the expression level of the transcript without exon 6A (Figure 6). However, the transcript containing the mutated, terminal exon 6A showed 2.5-fold higher levels compared to the wild type. The long internal exon 6A variant was about 5-fold more expressed, whereas for the short internal exon 6A variant the expression level changed dramatically, with about 3,000-fold increase compared to the wild type (Figure 6).

In order to assess the functional consequences of the mutation we conducted signal transduction studies using constructs consisting of two cDNAs covering exons 1–6 and 7–11 joined by a fragment of intron 6 including exon 6A with or without the A557C mutation (Figure 7A). Functionality at the transcriptional level was tested in transiently transfected COS7 cells. Using primer combinations directed to exon 6 and exon 7 of the *LHCGR*, RT-PCR yielded a predominantly expressed amplicon lacking exon 6A (Figure 7B). However, this pattern was completely reversed when analyzing the A557C mutation, which resulted in inclusion of both short and long variants of exon 6A. In functional experiments, increasing doses of hCG were able to significantly increase extracellular cAMP concentrations only when the cells were transfected with the expression vector containing the wild-type minigene, while response was practically abolished in the presence of the A557C mutation (Figure 7C). These data suggest that the mutation in exon 6A specifically alters the splicing pattern of the *LHCGR* gene, with a large increase of transcripts not contributing to the generation of the mature, full-length receptor protein, and it thereby prevents the physiological cAMP response to hCG stimulation.

Discussion

We detected a previously unrecognized, functional exon in the *LHCGR* gene that is present only in human and other primates. The appearance of novel exons in the primate lineage has been described for other receptor genes as well [11]. For example, a novel 5' exon was identified in the human tumor necrosis factor receptor gene type 2, which evolved during evolution from an ALU element to a fully functional exon present only in apes and humans [12]. Exon 6A was detected in all primate species analyzed, and we identified an IMAGE consortium clone from the Old World monkey *Macaca mulatta* testis in the EST-NCBI database that, despite its poor sequence quality, resembles the *LHCGR* exon 6A terminal variant. On the other hand, exon 6A-like sequences are not found in nonprimate species such as rat, mouse, dog, and fish. Therefore, this novel exon is confined to primates, where it is highly conserved, indicating strong functional constraints. We suggest that the genomic organization of the *LHCGR* gene in the primates be revised to include exon 6A, and hypothesize that the mRNA transcript without exon 6A encoding for the known *LHCGR* protein represents a splicing variant of the revised *LHCGR* gene (Figure S2) [13]. It is tempting to speculate that the appearance of exon 6A in the primate *LHCGR* gene is connected with the evolutionary appearance of CG in primates and its function during sexual

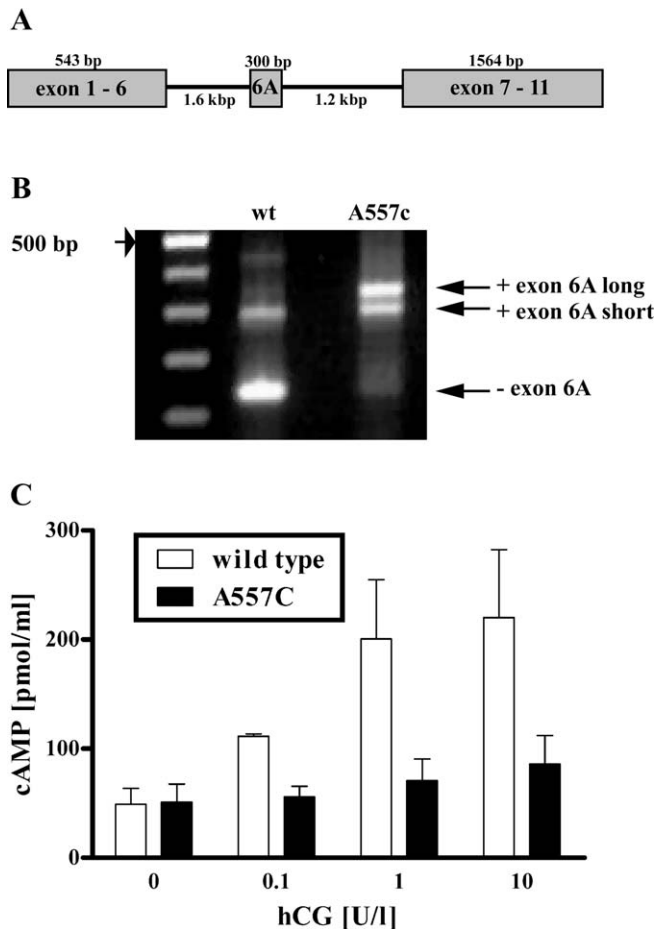

Figure 7. The A557C Mutation Abolishes LHCGR Response to hCG

(A) Minigenes were generated by ligating together the *LHCGR* cDNA from exons 1–6, the genomic DNA fragment encompassing exon 6 to exon 7 of the *LHCGR* gene from a patient carrying the A557C mutation and one control (wild type), and the *LHCGR* cDNA from exons 7–11.

(B) The constructs were cloned into the pTarget expression vector and transiently transfected in COS7 cells. RT-PCR of the region exon 6 to exon 7 revealed the predominant expression of the *LHCGR* mRNA lacking exon 6A (wt) for the wild-type *LHCGR*, while the A557C mutation led to predominant inclusion of exon 6A short and long (A557C). Signal transduction studies were performed as follows: Transfection efficiency was monitored by *Renilla* luciferase activity. Cells were stimulated by hCG for 3 h and extracellular cAMP was measured by RIA. Results of three independent experiments (mean \pm SEM) are shown. A significant ($p = 0.02$, Kruskal-Wallis test) dose-dependent increase of cAMP production was observed in the presence of the wild-type *LHCGR* minigene, whereas the response was abolished in the presence of the A557C mutation in exon 6A (C).

doi:10.1371/journal.pmed.0050088.g007

differentiation and in pregnancy recognition and maintenance [9,10].

Northern blot hybridizations revealed a unique pattern for exon 6A (Figure 5). The strength of the signal obtained with the exon 6A probe, which is at least comparable with the signal intensities of the full-length *LHCGR* mRNA, corroborates the finding obtained from the relative quantification studies (Figure 4), while the comet-like signal indicates a spectrum of transcripts of various lengths. If, as postulated, exon 6A-containing transcripts undergo NMD this pattern could derive from partially degraded transcripts from the *LHCGR* exon 6A internal variants and from the terminal exon 6 variant (calculated size approximately 650 bp). A

comparison with transcript patterns from other genes/exons undergoing NMD is not possible, since to our knowledge no other data on Northern blot hybridization of such transcripts have yet been performed.

The exact role of exon 6A is not fully understood yet. However, this is the first time to our knowledge that a human disease has been strongly associated with mutations in a cryptic exon that resembles a target for NMD and does not contribute to the final/mature protein structure [14]. We hypothesize that the mutations in exon 6A described in this paper result in modifications of the relative amounts of each *LHCGR* transcript in the Leydig cells, with highly increased accumulation of variants including exon 6A. This dramatic change overwhelms the NMD machinery and/or alters the pattern of protein translation and transportation, resulting in an insufficient amount of full-length, mature LHCGR protein at the cell surface. This assumption is corroborated by the *in vitro* functional data demonstrating the incapability of the A557C construct to produce enough functional receptor protein and by the fact that immunohistological staining for the LHCGR in testis sections of the A557C patient was negative, whereas Leydig cells from sections of intact testes and from LCH patients displaying a “classical” inactivating mutation, hindering proper membrane trafficking or signal transduction of the LHCGR, stained positive (Figure S4) [15,16].

The phenotype of exon 6A mutations, i.e., LCH and 46,XY DSD, is illuminating and supportive for a strong regulatory function of exon 6A. We propose that a complex network, including the novel transcripts described here and involving NMD, regulates *LHCGR* expression at both the transcriptional and translational level (Figure 8). The spectrum of *LHCGR* transcripts includes forms with and without exon 6A, but only the *LHCGR* mRNA transcript lacking exon 6A will lead to a functional protein [17]. The levels of such a “normal” transcript and its translation probably depend on the correct function of two distinct regulatory avenues processing the *LHCGR* mRNA including exon 6A. On one side the variant in which exon 6A acts as terminal exon may give rise to a protein potentially capable of hormone binding and/or of interaction with the mature LHCGR protein, thereby acting as modifier of hormone action. On the other side the correct processing of the *LHCGR* transcripts without exon 6A may depend on the elimination by NMD of the variants including the internal exon 6A. This complex pattern of *LHCGR* transcripts form a network which, considering the strong physiological constraints of LH/CG action, must be tightly regulated. We postulate that the strict regulation of this network is crucial for establishing the correct ratio between the transcripts, which in turn allows proper LHCGR functioning [18]. This view is supported by the fact that the internal and terminal exon 6A transcripts are physiologically detected along with the “normal” *LHCGR* mRNA in testes and granulosa cells. Should exon 6A be mutated, the NMD machinery might be unable to process the transcripts efficiently and, if a substantial part of them is translated, the functional LHCGR protein will compete with the truncated LHCGR protein derived from terminal and internal exon 6A variants [19,20]. Via dimerization of the full-length LHCGR with the truncated exon 6A variant, this might result in improper receptor trafficking [21].

Further studies on patients lacking “classical” genetic

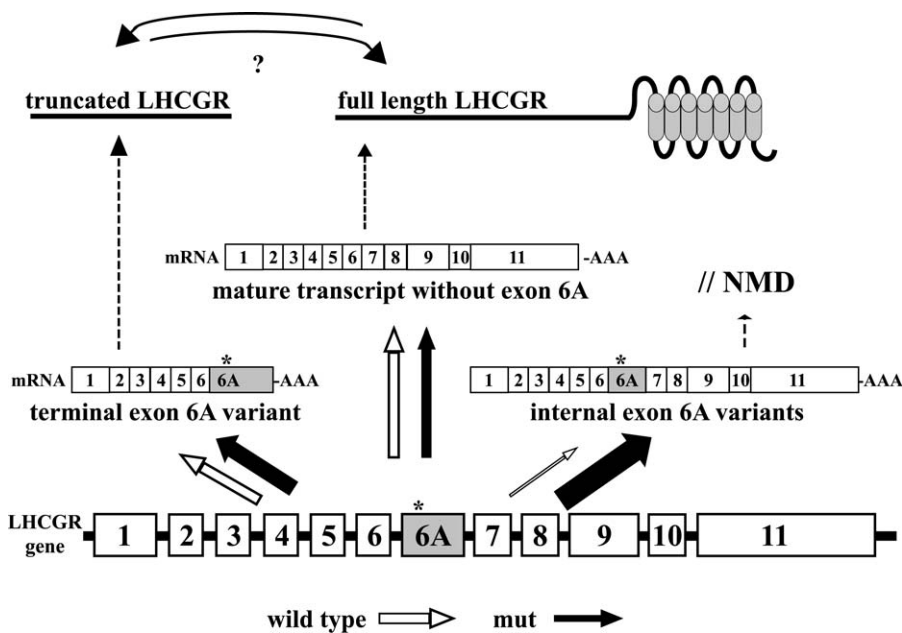

Figure 8. Transcriptional Network of the *LHCGR* Gene

Hypothetical model of the transcriptional network of the *LHCGR* gene including the novel exon 6A in the wild type (hollow arrows) or mutated (filled arrows) forms. The primary transcript of the *LHCGR* gene includes exon 6A, which can then be skipped in the mature mRNA giving rise to the full-length LHCGR protein, or is spliced into the terminal or internal exon 6A variants. Since exon 6A contains a stop codon (asterisk), the terminal variant may be translated into a truncated LHCGR protein, which remains mainly trapped within the cell and could hypothetically interact with the mature, full-length protein. Conversely, the stop codon in the internal 6A variants is recognized by the NMD pathway, which actively eliminates these transcripts. Under physiological conditions, both the mature transcript without exon 6A and the terminal 6A variant are present in roughly equal amounts in cells normally expressing the *LHCGR* (hollow arrows of equal width). In mutation(s) of exon 6A, the NMD surveillance mechanism is probably inadequate to eliminate the internal exon 6 variants, which accumulate in the cell and alter the relative abundance of the various transcripts, possibly resulting in an excessive increase of truncated LHCGR protein, incompatible with “normal” receptor function.
doi:10.1371/journal.pmed.0050088.g008

alterations in the *LHCGR* will shed new light on the pathophysiological role of exon 6A in LH/CG function and in clinical conditions of LH resistance.

Supporting Information

Figure S1. Exon 6A: Sequence Comparison, Phylogeny, and Genomic Organization

(A) Upper part: Genomic and cDNA nucleotide sequence comparison of exon 6A from human (*Homo sapiens*), chimpanzee (*Pan troglodytes*), cynomolgus monkey (*Macaca fascicularis*), marmoset (*Callithrix jacchus*), and lemur (*Eulemur coronatus*). Identical nucleotides are indicated by an asterisk. Sequences encompassing internal exon 6A are indicated by the grey line, while terminal exon 6A is indicated by a black line. Typical exon elements are given in bold italics or are boxed (poly[A] signal). Lower part: Comparison of the deduced amino acid sequence of exon 6A.

(B) Evolutionary pedigree of primate lineage evolution after Singer et al. (2004). The approximate time of DNA insertion is indicated by the arrows. Time scale in million of years (mya).

(C) Revised organization of the genomic region between exon 6 and 7 of the human, cynomolgus monkey, and mouse *LHCGR* gene. The exonic size is given above and the intronic size below the genomic elements.

Found at doi:10.1371/journal.pmed.0050088.sg001 (4.6 MB PDF).

Figure S2. Revised Complete Genomic Organization of the Human *LHCGR* Gene Now Consisting of 12 Exons

Exon sizes are given above the boxes, intron sizes below.

Found at doi:10.1371/journal.pmed.0050088.sg002 (9 KB PDF).

Figure S3. Immunofluorescence Localization of HA-Tagged LHCGR Proteins in Transiently Transfected COS7 Cells

(A) HA-tagged, wild-type terminal exon 6A LHCGR.

(B) HA-tagged, A557C terminal exon 6A LHCGR.

(C) Full-length HA-tagged LHCGR protein.

Both truncated LHCGR variants, wild-type and mutated, show a

predominantly intracellular localization (A and B), while the full-length receptor is localized intracellularly ([C] left) and membrane bound ([C] right). Immunofluorescence was performed using an HA antibody (1:200, Santa Cruz) and an anti-mouse IgG-FITC-labeled secondary antibody (1:64 dilution) and was visualized using either an inverse epifluorescence microscope (Axioskop II, Zeiss, Germany, [A–C] left column) or a confocal microscope (Leica TCS-SL, Germany [A–C] right column). For the confocal analysis the cells were permeabilized. Bar indicates 50 μ M.

Found at doi:10.1371/journal.pmed.0050088.sg003 (173 KB PDF).

Figure S4. Immunohistochemical Localization of the LHCGR in Human Testes

Leydig cells are positive for LHCGR in normal spermatogenesis (A) and in the testes of a patient with LCH caused by an F194A inactivating mutation in *LHCGR* (see Gromoll J, et al. [2002] Eur J Endocrinol 147: 597) (B), whereas no *LHCGR* expression can be detected in Leydig cells of the A557C patient (C). α -smooth muscle actin staining was used as positive control for the same patient (D). Bar indicates 100 μ M.

Found at doi:10.1371/journal.pmed.0050088.sg004 (357 KB PDF).

Figure S5. Functional Characterization of the T461I and the G558C Mutations

(A) Signal transduction hCG-dependent cAMP-responsive luciferase activity measured in wild-type LHR (filled circle), LHR-T461I mutant receptor (square), and empty expression plasmid pSG5 (triangles) expressing HEK293 cells. The hCG response of the mutant LH receptor is almost completely absent. *Renilla*, control of transfection efficiency; RLU, relative luciferase units. Construction of the expression plasmid pSG5-LHRWT and pSG5-LHR-T461I, culture and transfection of HEK293 cells, and the determination of cAMP-dependent luciferase response were performed as described previously (see Richter-Unruh A, et al. [2004] J Clin Endocrinol Metab 89: 5161).

(B) Sequencing results of the compound heterozygous patient displaying the exon 6A and exon 11 mutations.

(C) TaqMan RT-PCR quantification of internal exon 6 A inclusion in exon trap experiments using the wild-type or G558C exon 6A constructs. The expression of internal variants was analyzed after transfection in COS7 cells and RT-PCR of pSPL3 constructs containing the wild type (WT) exon 6A (along with 150 bp 5' and 3' of it: see Figure 2) or exon 6A after introduction of the G558C mutation as described in Figure 4. Densitometric quantification (in arbitrary units (AU) of internal exon 6A variants RT-PCR results (both short and long variant together) of two independent experiments. Results are mean \pm standard error of the mean (SEM).

Found at doi:10.1371/journal.pmed.0050088.sg005 (126 KB PDF).

Table S1. Distribution of Exon 6A SNPs in Patients and Controls

Found at doi:10.1371/journal.pmed.0050088.st001 (42 KB DOC).

Accession Numbers

The accession numbers of the items discussed in this paper are: human *LHCGR* gene (GeneID 3973; <http://www.ncbi.nlm.nih.gov/>); Leydig cell hypoplasia (MIM 152790); and exon 6A clone from *M. mulatta* testis (EST database CD766751; <http://www.ncbi.nlm.nih.gov/>).

Acknowledgments

This paper is dedicated to Prof. Dr. E. Nieschlag and to S. Nieschlag, MA, for their tireless efforts on behalf of reproductive endocrinology and for supporting our work over the years. We thank E. Lahrman, N. Terwort, and R. Sandhowe for invaluable technical assistance. We are grateful to Prof. Dr. N. Albers for providing the DNA of one patient, to Dr. V. Nordhoff and Dr. S. Kliesch for providing human granulosa cells and testis tissue and to Dr. C. M. Luetjens for histological analysis of testicular samples, immunohistochemistry of LHCGR exon 6A protein expression, and help in preparing the illustrations. The LHCGR antibody was kindly provided Dr. F. Malavasi, University of Turin, Italy.

Author contributions. NK performed the experiments and wrote parts of the manuscript, MS designed experiments and wrote the manuscript, AR-U enrolled the patients, APNT performed the functional experiments on the T461I mutation, and JG designed the study and wrote the manuscript.

References

- Ascoli M, Fanelli F, Segaloff DL (2002) The lutropin/choriogonadotropin receptor, a 2002 perspective. *Endocr Rev* 23: 141–174.
- Themmen APN, Huhtaniemi IT (2000) Mutations of gonadotropins and gonadotropin receptors: Elucidating the physiology and pathophysiology of pituitary-gonadal function. *End Rev* 21: 551–583.
- Zenteno JC, Canto P, Kofman-Alfaro S, Mendez JP (1999) Evidence for genetic heterogeneity in male pseudohermaphroditism due to Leydig cell hypoplasia. *J Clin. Endocrinol Metab* 84: 3803–3806.
- Richter-Unruh A, Martens JW, Verhoef-Post M, Wessels HT, Kors WA, et al. (2002) Leydig cell hypoplasia: cases with new mutations, new polymorphisms and cases without mutations in the luteinizing hormone receptor gene. *Clin Endocrinol (Oxf)* 56: 103–112.
- Gromoll J, Weinbauer GF, Skaletsky H, Schlatt S, Rocchietti-March M, et al. (1999) The old world monkey DAZ gene yields insights into the evolution of the DAZ gene cluster on the human Y chromosome. *Hum Mol Genet* 8: 2017–2024.
- Livak KJ, Schmittgen TD (2001) Analysis of relative gene expression data using real-time quantitative PCR and the 2(-Delta Delta C(T) method). *Methods* 25: 402–408.
- Sheets MD, Ogg SC, Wickens MP (1990) Point mutations in AAUAAA and the poly (A) addition site: effects on the accuracy and efficiency of cleavage and polyadenylation in vitro. *Nucleic Acids Res* 18: 5799–5805.
- Gromoll J, Wistuba J, Terwort N, Godmann M, Müller T, et al. (2003) A new subclass of the luteinizing hormone/chorionic gonadotropin receptor lacking exon 10 messenger RNA in the New World monkey (*Platyrrhini*) lineage. *Biol Reprod* 69: 75–80.
- Maston GA, Ruvolo M (2002) Chorionic gonadotropin has a recent origin within primates and an evolutionary history of selection. *Mol Biol Evol* 19: 320–335.
- Lewis BP, Green RE, Brenner SE (2003) Evidence for the widespread coupling of alternative splicing and nonsense-mediated mRNA decay in humans. *Proc Natl Acad Sci U S A* 100: 189–192.
- Modrek B, Lee CJ (2003) Alternative splicing in the human, mouse and rat genomes is associated with an increased frequency of exon creation and/or loss. *Nat Genet* 2: 177–180.
- Singer SS, Mannel DN, Hehlhans T, Brosius J, Schmitz J (2004) From “junk” to gene: curriculum vitae of a primate receptor isoform gene. *J Mol Biol* 341: 883–886.
- Lou H, Gagel RF (2001) Alternative ribonucleic acid processing in endocrine systems. *Endocr Rev* 22: 205–225.
- Smits G, Campillo M, Govaerts C, Janssens V, Richter C, et al. (2003) Glycoprotein hormone receptors: determinants in leucine-rich repeats responsible for ligand specificity. *EMBO J* 22: 2692–2703.
- Gromoll J, Schulz A, Gromoll J, Schulz A, Borta H, et al. (2002) Homozygous mutation within the conserved Ala-Phe-Asn-Glu-Thr motif of exon 7 of the LH receptor causes male pseudohermaphroditism. *Eur J Endocrinol* 147: 597–608.
- Misrahi M, Meduri G, Pissard S, Bouvattier C, Beau I, et al. (1997) Comparison of immunocytochemical and molecular features with the phenotype in a case of incomplete male pseudohermaphroditism associated with a mutation of the luteinizing hormone receptor. *J Clin Endocrinol Metab* 82: 2159–2165.
- Jiang X, Russo IH, Russo J (2002) Alternately spliced luteinizing hormone/human chorionic gonadotropin receptor mRNA in human breast epithelial cells. *Int J Oncol* 20: 735–738.
- Stamm S, Ben-Ari S, Rafalska I, Tang Y, Zhang Z, et al. (2005) Functions of alternative splicing. *Gene* 344: 1–20.
- Nakamura K, Yamashita S, Omori Y, Minegishi T (2004) A splice variant of the human LH receptor modulates the expression of wild type human LH receptor. *Mol Endocrinol* 18: 1461–1470.
- Zhang R, Buczek E, Dufau ML (1996) Requirement of cysteine residues in exons 1–6 of the extracellular domain of the luteinizing hormone receptor for gonadotropin binding. *J Biol Chem* 271: 5755–5760.
- Park PSH, Palcewski K (2005) Diversifying the repertoire of G protein-coupled receptors through oligomerization. *Proc Natl Acad Sci U S A* 102: 8793–8794.

Editors' Summary

Background. A person's sex is determined by their complement of X and Y (sex) chromosomes. Someone who has two X chromosomes is genetically female and usually has ovaries and female external sex organs. Someone who has an X and a Y chromosome is genetically male and has testes and male external sex organs. Sometimes, though, the development of the reproductive organs proceeds abnormally, resulting in a person with an "intersex" condition whose chromosomes, gonads (ovaries or testes), and external sex organs do not correspond. Leydig cell hypoplasia (LCH; also called male pseudohermaphroditism or a disorder of sex development) is an XY female intersex condition. People with this inherited condition develop testes but also have a vagina (which is not connected to a womb), and they do not develop breasts or have periods. This mixture of sexual characteristics arises because the Leydig cells in the testes are underdeveloped. Leydig cells normally secrete testosterone, the hormone that promotes the development and maintenance of male sex characteristics. Before birth, chorionic gonadotropin (CG; a hormone made by the placenta) stimulates Leydig cell development and testosterone production; after birth, luteinizing hormone (LH), which is made by the pituitary gland, stimulates testosterone production. Both hormones bind to the LH/CG receptor, a protein on the surface of Leydig cells. In LCH, this receptor either does not bind CG and LH or fails to tell the Leydig cells to make testosterone.

Why Was This Study Done? The gene that encodes the LH/CG receptor is called *LHCGR*. Several mutations (genetic changes) that inactivate the LH/CG receptor have been identified in people with LCH. However, the *LHCGR* gene is apparently normal in 50% of people with this intersex condition. In this study, the researchers examine the *LHCGR* gene in detail to try to find the underlying genetic defect in these individuals.

What Did the Researchers Do and Find? The researchers used several molecular biology techniques to identify a new exon—exon 6A—within the human *LHCGR* gene. (Exons are DNA sequences that contain the information for making proteins; introns are DNA sequences that interrupt the coding sequence of a gene. Both introns and exons are transcribed into messenger RNA [mRNA] and the exons are then "spliced" together to make the mature mRNA, which is translated into protein.) The researchers identify several differently spliced *LHCGR* mRNA transcripts that contain exon 6A—a terminal exon 6A mRNA that contains exons 1–6 and exon 6A, and two internal exon 6A mRNAs that also contain exons 7–11. The researchers report that human testes express high levels of the terminal exon 6A transcript, which is translated into a short version of LHCGR protein that remains within the cell (full-length LHCGR moves to the cell surface). By contrast, testes contain low levels of the internal exon 6A mRNAs. This is because exon 6A contains two premature stop codons (DNA sequences that mark the end of a

protein), which trigger "nonsense-mediated decay" (NMD), a cellular surveillance mechanism that regulates protein synthesis by degrading mRNAs that contain internal stop codons. When the researchers screened 16 people with LCH but without known mutations in the *LHCGR* gene, three had mutations in exon 6A. Laboratory experiments show that these mutations greatly increased the amounts of the internal exon 6A transcripts present in cells and interfered with the cells' normal response to chorionic gonadotropin.

What Do These Findings Mean? These findings identify a new, functional exon in the *LHCGR* gene and show that mutations in this exon cause some cases of LCH. This is the first time that a human disease has been associated with mutations in an exon that is a target for NMD. In addition, these findings provide important insights into how the LHCGR is regulated. The researchers speculate that a complex network that involves the exon 6A-containing transcripts and NMD normally tightly regulates the production of functional LHCGR already at the transcriptional level. When mutations are present in exon 6A, they suggest, NMD is the predominant pathway for all the exon 6A-containing transcripts, thereby drastically decreasing the amount of functional LHCGR.

Additional Information. Please access these Web sites via the online version of this summary at <http://dx.doi.org/10.1371/journal.pmed.0050088>.

- The MedlinePlus Encyclopedia has a page on intersex conditions (in English and Spanish)
- Wikipedia has pages on intersexuality and on the LH/CG receptor (note that Wikipedia is a free online encyclopedia that anyone can edit; available in several languages)
- The Intersex Society of North America provides information and support for the parents of children with intersex conditions
- The Androgen Insensitivity Syndrome Support Group also provides some general information about intersex conditions, including information about LCH and other XY female conditions (in several languages)
- Sequence-Structure-Function-Analysis (SSFA), run by a group of researchers in Germany (Leibniz-Institut für Molekulare Pharmakologie; Humboldt-Universität zu Berlin), is a database dealing the sequence, structure, and function of glycoprotein hormone receptors
- Glycoprotein-hormone Receptors Information System (GRIS), from Université Libre de Bruxelles and Institut de Recherche Interdisciplinaire en Biologie Humaine et Moléculaire, is a database giving structural information on the LHCGR